

**dyson** pure cool

Operating manual

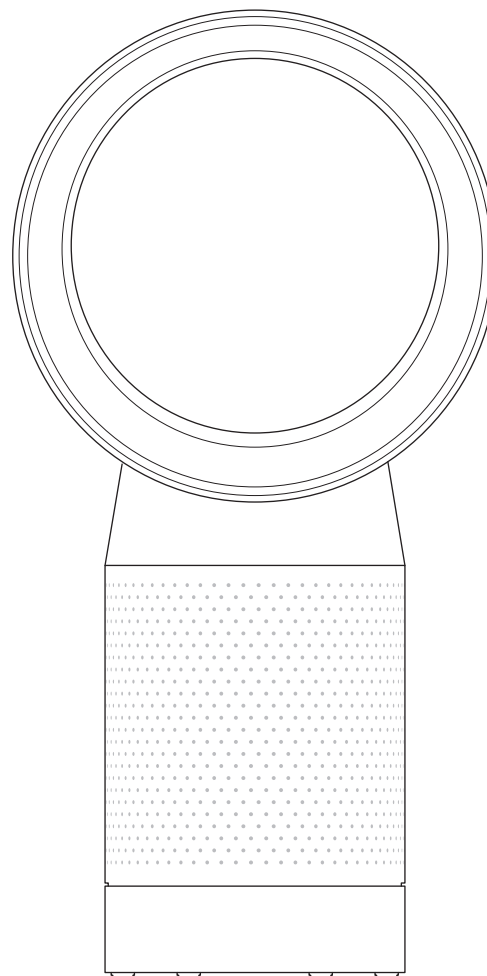

DP04

## Contents

### Getting started

- 4 Registration
- 6 Important safety instructions
- 9 Assembly
- 10 Controls
- 11 Additional functions
- 12 Connecting to the Dyson Link app
- 14 Information menu
- 16 Auto mode
- 17 Airflow
- 18 Night mode
- 19 Oscillation

### Maintenance

- 20 Changing the glass HEPA filters
- 22 Changing the carbon filters
- 24 Cleaning

### Important information

- 25 Troubleshooting
- 26 Additional information

Thank you for choosing to buy  
a Dyson purifying fan

### We're here to help



#### Online

UK: [www.dyson.co.uk/support](http://www.dyson.co.uk/support)  
ROI: [www.dyson.ie/support](http://www.dyson.ie/support)



#### Support centre

Monday to Friday 8am-8pm &  
Saturday and Sunday 8am-6pm  
UK: 0800 298 0298  
[askdyson@dyson.co.uk](mailto:askdyson@dyson.co.uk)  
ROI: 01 475 7109  
[askdyson@dyson.ie](mailto:askdyson@dyson.ie)



#### Download the Dyson Link app

The Dyson Link app allows you to control, monitor, customise and get automatic setting upgrades for your appliance on your mobile device. Search for the Dyson Link app on the App Store or Google Play.

# Registration

After registering your free 2 year guarantee, your Dyson appliance will be covered for parts and labour (excluding filters) for 2 years from the date of purchase, subject to the terms of the guarantee. Your serial number can be found on your rating plate which is on the base of the appliance.

Note your serial number for future reference.

This illustration is for example purposes only.



Small details may vary slightly from those shown.

## 4 easy ways to register your free 2 year guarantee



**Register with your smartphone**  
Download the Dyson Link app and you will be taken through registration as part of the set up.



**Register online**  
Visit our website to register your full parts and labour guarantee online.  
[www.dyson.co.uk/register](http://www.dyson.co.uk/register)  
[www.dyson.ie/register](http://www.dyson.ie/register)



**Register by phone**  
Call our dedicated helpline.  
Open Monday to Friday 8am-8pm  
& Saturday and Sunday 8am-6pm.  
**UK:** 0800 298 0298  
**ROI:** 01 475 7109



**Register by mail**  
Complete and return the form to Dyson in the envelope supplied.

## IMPORTANT SAFETY INSTRUCTIONS

**BEFORE USING THIS APPLIANCE READ ALL INSTRUCTIONS AND CAUTIONARY MARKINGS IN THIS MANUAL AND ON THE APPLIANCE**

When using an electrical appliance, basic precautions should always be followed, including the following:

### WARNING

**THE APPLIANCE AND THE REMOTE CONTROL BOTH CONTAIN MAGNETS.**

1. Pacemakers and defibrillators may be affected by strong magnetic fields. If you or someone in your household has a pacemaker or defibrillator, avoid placing the remote control in a pocket or near to the device.
2. Credit cards and electronic storage media may also be affected by magnets and should be kept away from the remote control and the top of the appliance.

### WARNING

These warnings apply to the appliance, and also where applicable, to all tools, accessories, chargers or mains adaptors.

**TO REDUCE THE RISK OF FIRE, ELECTRIC SHOCK, OR INJURY:**

3. This Dyson appliance can be used by children aged from 8 years and above and persons with reduced physical, sensory or reasoning capabilities, or lack of experience and knowledge, only if they have been given supervision or instruction by a responsible person concerning use of the appliance in a safe way and understand the hazards involved. Cleaning and user maintenance should not be performed by children without supervision.
4. Ensure that the appliance is fully assembled in line with the instructions before use.
5. Do not allow to be used as a toy. Close attention is necessary when used by or near children. Children should be supervised to ensure that they do not play with the appliance.
6. Use only as described in this Dyson Operating Manual. Do not carry out any maintenance other than that shown in this manual, or advised by the Dyson Customer Care Helpline.

7. Suitable for dry location ONLY. Do not use outdoors or on wet surfaces and do not expose to water or rain.
8. Do not handle any part of the plug or appliance with wet hands.
9. Do not operate any appliance with a damaged cable or plug. Discard the appliance or return to an authorised service facility for examination and/or repair. If the supply cable is damaged it must be replaced by Dyson, its service agent or similarly qualified person in order to avoid a hazard.
10. If the appliance is not working as it should, has received a sharp blow, has been dropped, damaged, left outdoors, or dropped into water, do not use and contact the Dyson Customer Care Helpline.
11. Do not stretch the cable or place the cable under strain. Keep cable away from heated surfaces.
12. Do not route the cable under furniture or appliances. Do not cover cable with throw rugs, runners or similar coverings. Arrange cable away from traffic area and where it will not be tripped over.
13. Do not unplug by pulling on the cable. To unplug, grasp the plug, not the cable. The use of an extension cable is not recommended.
14. Do not put any object into openings or the inlet grille. Do not use with any opening blocked; keep free of dust, lint, hair, and anything that may reduce airflow.
15. Do not use any cleaning agents or lubricants on this appliance. Unplug before cleaning or carrying out any maintenance.
16. Always carry the appliance by the base, do not carry it by the loop amplifier.
17. Turn off all controls before unplugging. Unplug from socket when not in use for extended periods. To avoid a tripping hazard, safely coil the cable.
18. Do not use near furnaces, fireplaces, stoves or other high temperature heat sources.
19. Do not use in conjunction with or directly next to an air freshener or similar products. Do not spray or apply perfumes directly on or near the filter. Keep essential oils and chemicals away from the appliance.
20. **WARNING: Chemical Burn and Choking Hazard.** Keep batteries away from children. This product contains a lithium button/coin cell battery. If a new or used lithium button/coin cell battery is swallowed or enters the body, it can cause severe internal burns and can lead to death in as little as 2 hours. Always completely

secure the battery compartment. If the battery compartment does not close securely, stop using the product, remove the batteries, and keep it away from children. If you think batteries might have been swallowed or placed inside any part of the body, seek immediate medical attention.

21. This appliance is only to be used with the power supply unit provided with it.

## READ AND SAVE THESE INSTRUCTIONS

This Dyson appliance is intended for household use only.

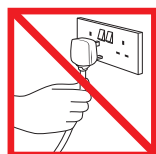

Do not pull on the cable.

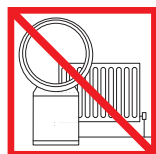

Do not store near heat sources.



Do not use near naked flames.



Do not carry by the air loop amplifier. The air loop amplifier is not a handle.



Do not spray scented products such as air freshener or perfume near the filter or the appliance.

## Assembly

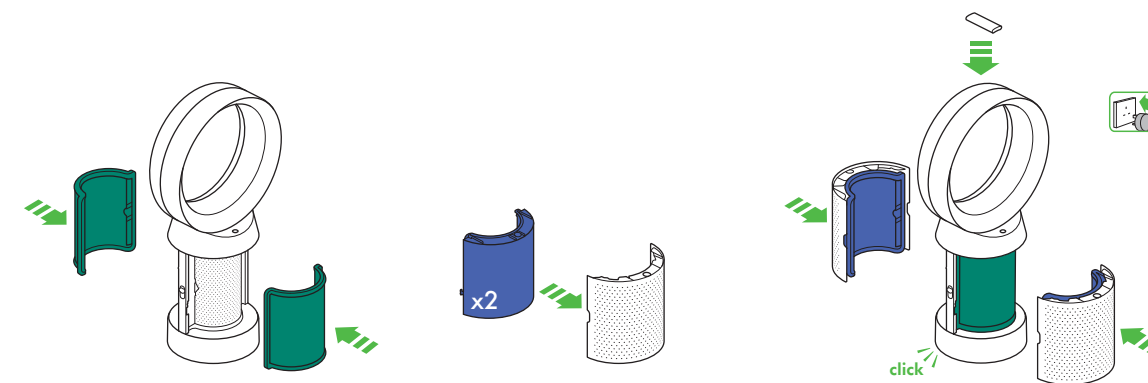

Use both hands to lift the appliance out of the box, taking care to hold by the base of the appliance only.

Do not lift out by the amplifier loop.

Take the carbon filters out of the box and remove the protective packaging.

Attach both carbon filters to the appliance.

Remove the glass HEPA filters from their protective packaging and push into the shrouds until secure.

Position the shrouds onto the base and push gently until they click securely into place.

Place the remote control on the top of the appliance with the buttons facing down.

Plug in and switch on.

## Controls

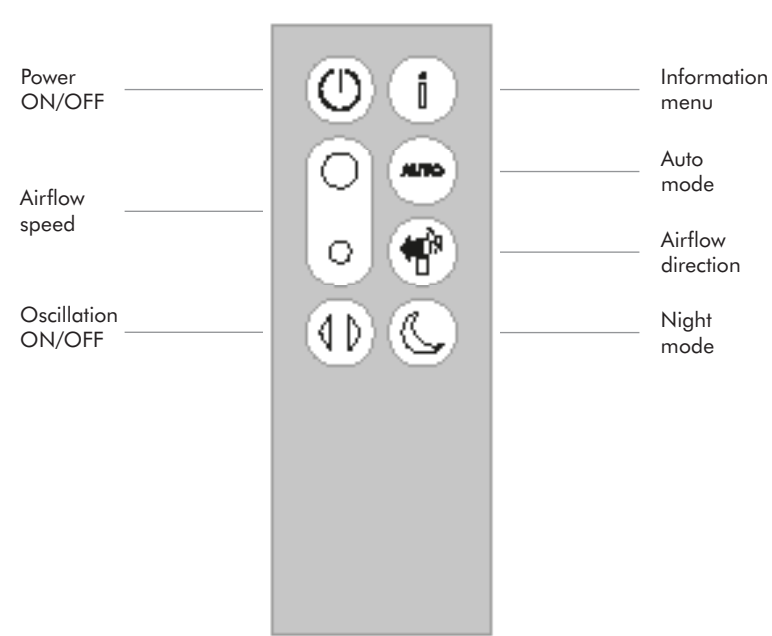
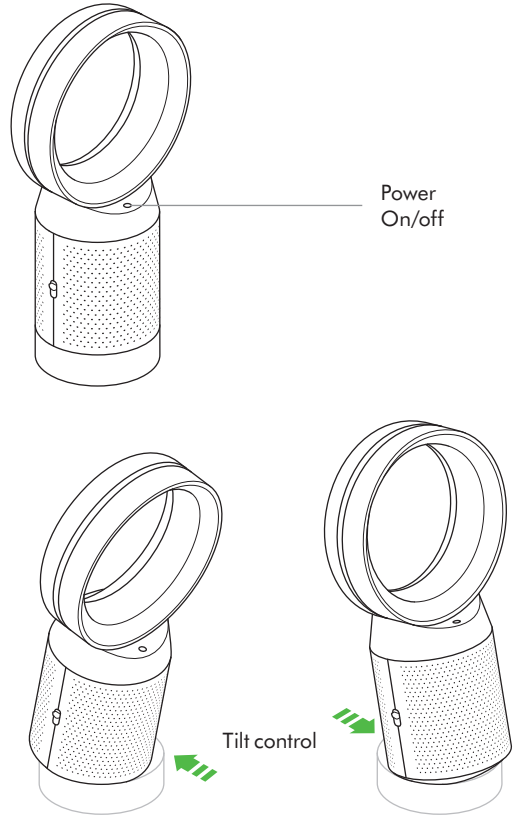

## Additional functions

### Power ON/OFF

Press the Power ON/OFF button on the appliance or remote control to stop the purifying fan. The appliance will continue to monitor the air quality.

### Continuous monitoring

The continuous monitoring function will:

- Collect extensive environmental information (see the "Information menu" section).
  - Allow historical air quality information to be displayed on the screen and in the Dyson Link app.
- Continuous monitoring is active at all times unless standby is selected.

To stop continuous monitoring, press and hold the Auto mode button for 5 secs.

### Standby

To exit standby and reactivate the appliance press the Power ON/OFF button on the appliance or remote control.

## Connecting to the Dyson Link app



The Dyson Link app allows you to control, schedule, monitor, and customise your settings for your appliance from your mobile device.

Wi-Fi is enabled by default. To disable or enable the Wi-Fi press and hold the ON/OFF button on the appliance for 5 Seconds.

Apple and the Apple logo are trademarks of Apple Inc., registered in the U.S. and other countries. App Store is a service mark of Apple Inc., registered in the U.S. and other countries.

Google Play and the Google Play logo are trademarks of Google Inc.



Plug in your appliance to the mains electricity supply and turn on the power.

Check your mobile device is compatible with the app, switched on, connected to a Wi-Fi network and Bluetooth enabled.

If you do not already have the Dyson Link app you will need to download it from the App Store or Google Play.

Open the Dyson Link app and follow the instructions to create a new account if you do not already have one.

Follow the on-screen instructions to pair your appliance to the Dyson Link app.

You will now be able to use the Dyson Link app to create custom settings, monitor information from the appliance, control your appliance, schedule use and also keep up to date with system upgrades.

If you experience problems downloading the Dyson Link app or pairing your device; first check that you are connected to a Wi-Fi network and Bluetooth is enabled on your mobile device and try again.

If you continue to experience problems downloading the app or pairing your device, please contact the Dyson Helpline.

## Information menu

Scroll through the options to monitor the performance of your appliance.

The menu will also allow you to access information about the pollutants in the air and the temperature and humidity levels.

When a particular type of pollutant causes air quality to decrease, the symbol for that pollutant will show in the display.

Small details may vary slightly from those shown.

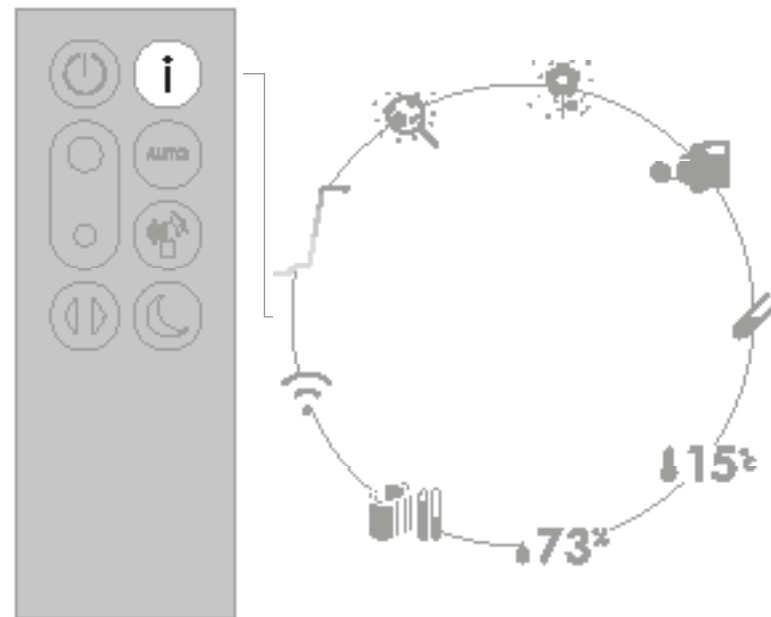

**Indoor air quality - 12 seconds**  
Monitor the current air quality with a graph showing the last 12 seconds of data.



**Particulate matter (PM2.5)**  
Microscopic particles up to 2.5 microns in size, suspended in the air we breathe. These include smoke, bacteria and allergens.



**Particulate matter (PM10)**  
Larger microscopic particles up to 10 microns in size, suspended in the air we breathe. These include dust, mould and pollen.



**Nitrogen dioxide and other oxidising gases**  
These potentially harmful gases are released into the air by combustion, for example the burning gas when cooking and in vehicle exhaust emissions.

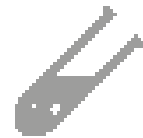

**Volatile organic compounds**  
VOC's are typically odours that may be potentially harmful. These can be found in cleaning products, paints and new furnishings.



**Indoor temperature**  
Monitor the ambient temperature to help maintain a comfortable environment.



**Indoor humidity**  
The amount of water vapour in the air, shown as a percentage of the maximum possible humidity at the current temperature.



**Filters**  
The remaining filter life is shown in the display and will indicate when either filter needs replacing.



**Wi-Fi**  
The current status of connection to the Wi-Fi network.



## Auto mode

When Auto mode is selected the on-board sensors will intelligently adjust the settings of the appliance according to the quality of air.

The appliance will pause once the sensors detect that the target air quality level has been reached.

The sensors will continue to monitor the air quality, switching the appliance back on when air quality levels have dropped.

Customise your Auto mode and air quality settings in the Dyson Link app.



## Airflow

Air will be purified continuously, whether the air is set to flow from the front or the back.

For purification and cool airflow, select the airflow direction to the front.

For purification without cool airflow from the front, select the airflow direction to the back.

Press the Airflow speed button to increase and decrease the airflow speed.

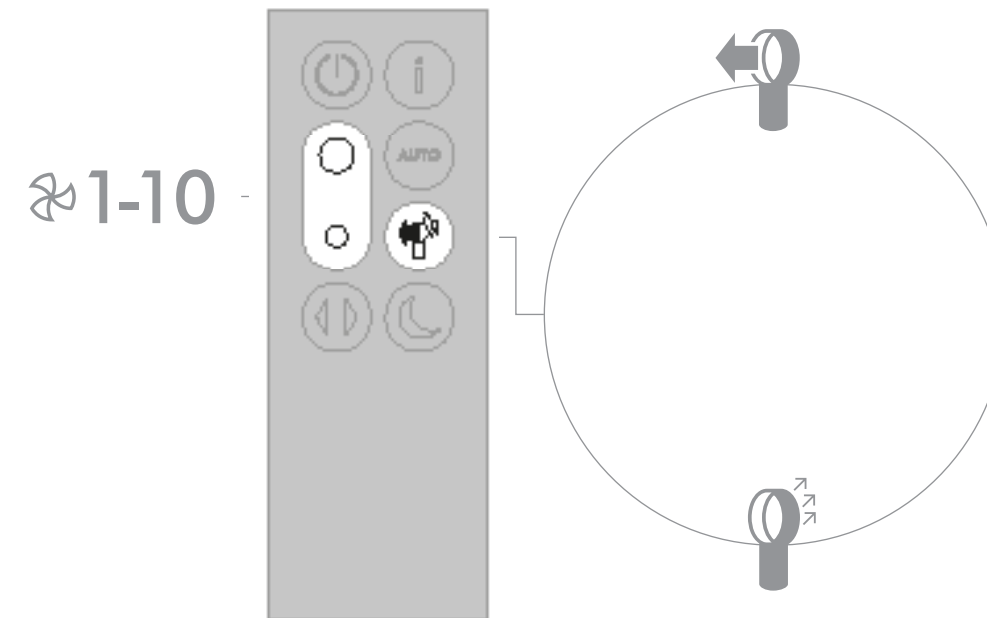

## Night mode

Night mode will dim the display and the appliance will run more quietly, making it ideal for use while sleeping.

If Auto mode has been set, Night mode will reduce airflow speeds to range from 1 to 4.

You can manually change the airflow from 1-10.

Customise your Night mode settings in the Dyson Link app.

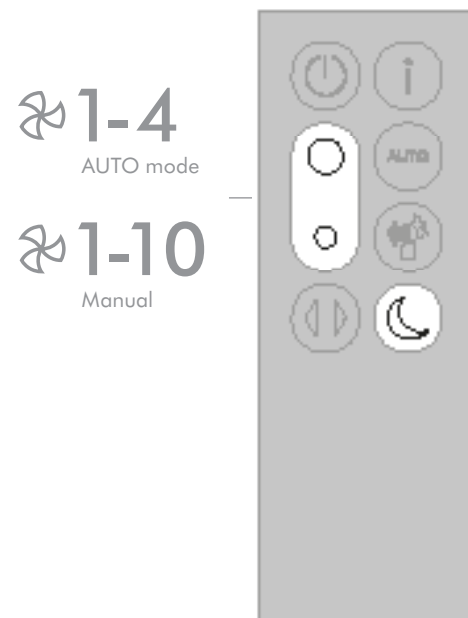

## Oscillation

Press the Oscillation button to scroll through the options from 0° to 350°.

Customise your oscillation settings in the Dyson Link app and it will appear as an option as you scroll through.

Small details may vary slightly from those shown.

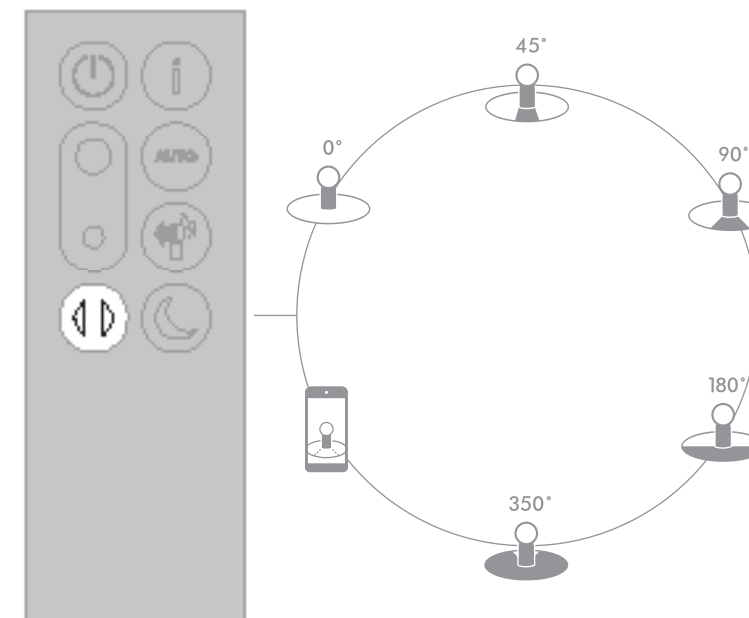

## Changing the glass HEPA filters

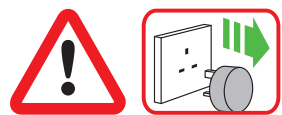

**Important:** Always unplug the appliance before changing filters. The remaining filter life is shown in the display and will indicate when the non-washable glass HEPA filter needs replacing.

Dispose of used filter units in accordance with local regulations.

1

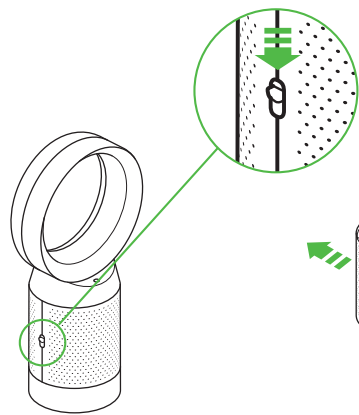

Unplug the appliance from the mains electricity supply. Slide the buttons down on both sides of the shrouds.

2



The shrouds will release with the glass HEPA filters attached.

3

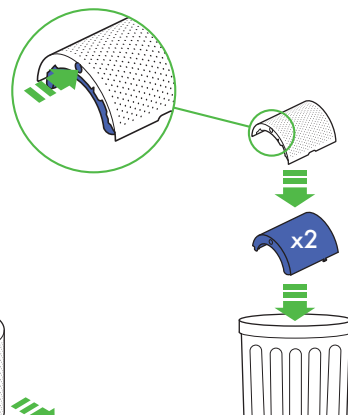

Empty the glass HEPA filters directly into the bin by pushing in both the purple tabs on the shrouds.

4

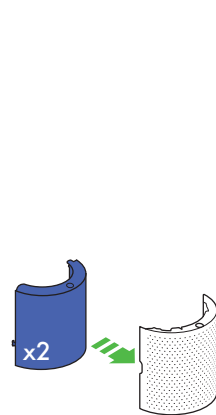

Push the new glass HEPA filters into the shrouds until secure.

5

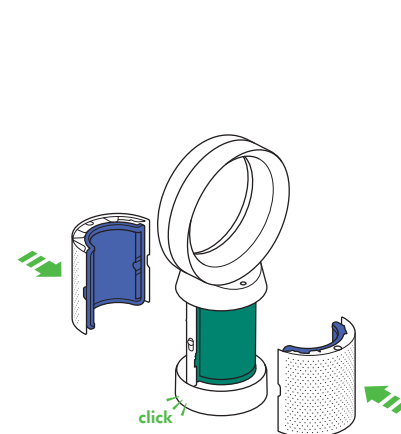

Push the shrouds until they click back into position in the base.

6



Plug the appliance in to the mains electricity supply and switch on.

## Important

7

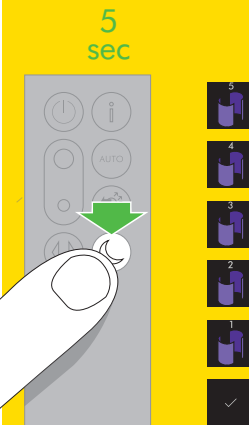

Press and hold the Night mode button on the remote control.

The display on the appliance will countdown from five, finishing with the default screen. The glass HEPA filter level will be reset and the appliance is ready to use.

## Changing the carbon filters

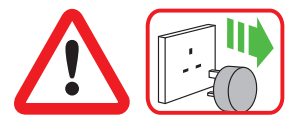

**Important: Always unplug the appliance before changing filters.** The remaining filter life is shown in the display and will indicate when the non-washable carbon filter needs replacing.

Dispose of used filter units in accordance with local regulations.

1

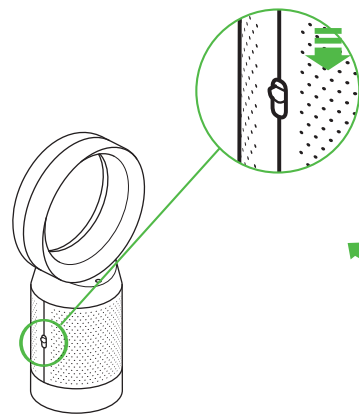

Unplug the appliance from the mains electricity supply.

Slide the buttons down on both sides of the shrouds.

2

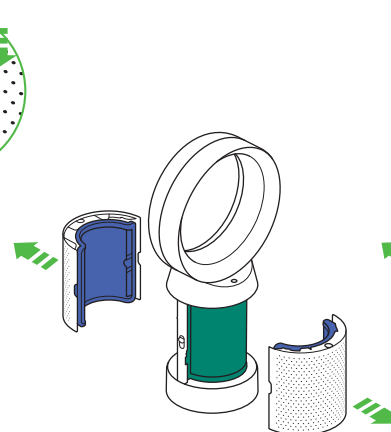

The shrouds will release with the glass HEPA filters attached.

3

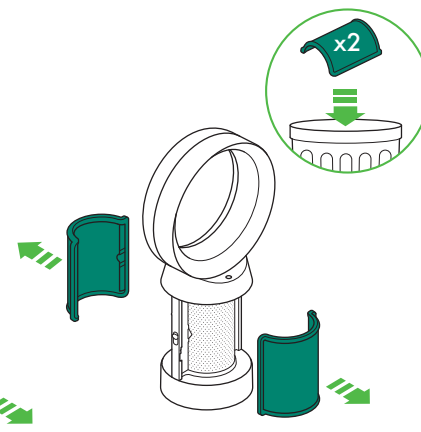

To remove the carbon filters: pull the tabs on both sides of the filters.

Dispose of the carbon filters in the bin.

4

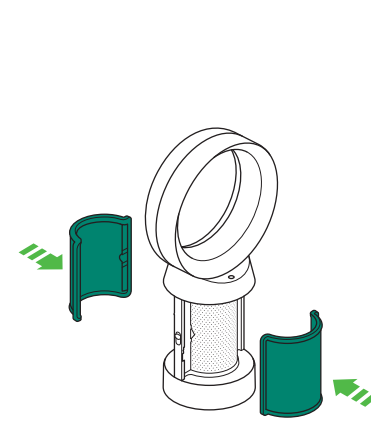

Push the new carbon filters onto the base until secure.

5

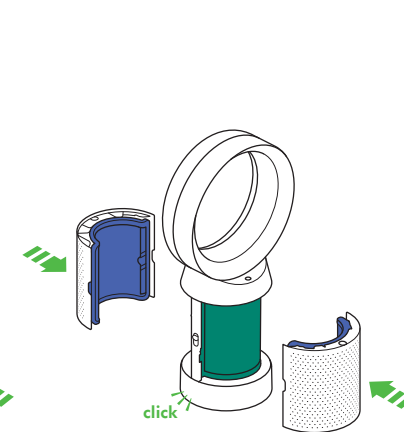

Push the shrouds until they click back into position in the base.

6



Plug the appliance in to the mains electricity supply and switch on.

## Important

7

5  
sec

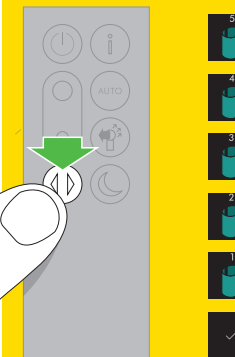

Press and hold the Oscillation button on the remote control.

The display on the appliance will countdown from five, finishing with the default screen. The carbon filter level will be reset and the appliance is ready to use.

## Cleaning

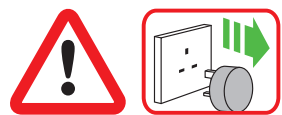

To ensure that your appliance works efficiently, it is important to clean and check for blockages regularly.

Unplug your appliance from the mains electricity supply before cleaning.

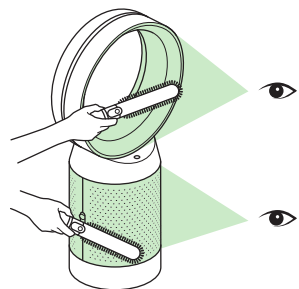

Dust may accumulate on the surface of the machine. Wipe dust from the loop amplifier, filter unit and other parts with a dry or damp cloth.

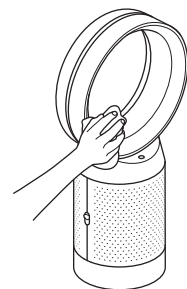

Look for blockages in the air inlet holes in the filter and the small aperture inside the loop amplifier.

Use a soft brush to remove dust and debris.

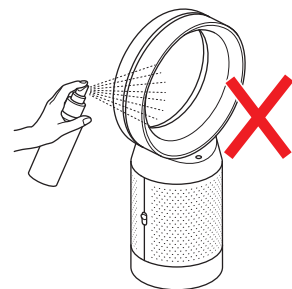

Do not use detergents or polishes to clean the appliance.

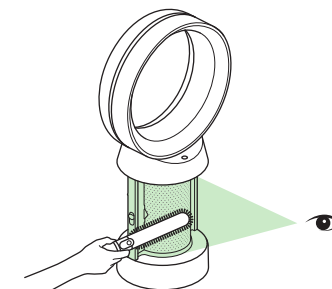

To remove a blockage:

Remove the filter shrouds and look for blockages in the air inlet holes under the filters.

Use a soft brush to remove dust and debris.

If an error code is displayed, first try unplugging the appliance and plugging it in again.

If an error code continues to be displayed, contact the Dyson Helpline.

## Troubleshooting

For further information and support:  
Online:  
UK: [www.dyson.co.uk/support](http://www.dyson.co.uk/support)  
ROI: [www.dyson.ie/support](http://www.dyson.ie/support)  
On the phone:  
UK: 0800 298 0298  
ROI: 01 475 7109  
Monday to Friday 8am-8pm &  
Saturday and Sunday 8am-6pm

If the appliance has been used without a filter in place or the filters have not been changed when prompted, blockages may occur.

## Additional information

### CONTROL WITHOUT THE REMOTE

- The appliance can be controlled through your Dyson Link app.

### DYSON LINK APP CONNECTIVITY

- You must have a live internet connection in order for the Dyson Link app to work.
- The appliance can connect to either 2.4GHz or 5GHz networks which includes most modern routers. Check your router documentation for compatibility.
- The Dyson Link app requires an iOS device with at least iOS version 10\* or an Android device with at least Android version 5.
- Your mobile device must have Bluetooth 4.0 support (Bluetooth Low Energy) in order to set up a connection with the appliance. Check your device specification for compatibility.
  - BLE/Wi-Fi 2.4GHz – 2.5GHz, 0.1W max
  - Wi-Fi 5.170GHz – 5.835GHz, 0.1W max
  - Supported Wi-Fi protocols:
    - IEEE802.11a
    - IEEE802.11b (Not recommended)
    - IEEE802.11g
    - IEEE802.11n
  - Networked standby: 1.0 W

### REPLACEABLE PARTS

#### BATTERY REPLACEMENT

#### CAUTION

- Unscrew the battery compartment on the remote control. Loosen the base and pull to remove the battery.
- Do not install backwards or short circuit the batteries.
- Do not attempt to dismantle or charge the batteries. Keep away from fire.
- Follow battery manufacturers' instructions when installing new batteries (battery type CR 2032).
- Always replace the screw in the remote control.

#### NON-WASHABLE FILTER UNITS

- Your filter units are non-washable and non-recyclable.
- To replace your filter units follow the steps as shown.

- Failure to replace the filter units when prompted may result in changes to product performance and appearance.
- New filter units can be purchased at [www.dyson.co.uk/support](http://www.dyson.co.uk/support) or [www.dyson.ie/support](http://www.dyson.ie/support).

#### AUTO MODE

- A period of 6 days is required after the appliance is first used for the sensor to calibrate. During this period the appliance may be more sensitive to VOCs (such as odours) than normal.

#### DISPOSAL INFORMATION

- Dyson products are made from high grade recyclable materials. Recycle where possible.
- Dispose of or recycle the battery in accordance with local ordinances or regulations.
- This marking indicates that this product should not be disposed with other household wastes throughout the EU. To prevent possible harm to the environment or human health from uncontrolled waste disposal, recycle it responsibly to promote the sustainable reuse of material resources. To return your used device, please use the return and collection systems or contact the retailer where the product was purchased. They can take this product for environmentally safe recycling.
- Keep the used batteries away from children as these can still harm children if swallowed.
- Your filter units are non-washable and non-recyclable.
- Dispose of the exhausted filter units in accordance with local ordinances or regulations.
- The battery should be removed from the product before disposal.

#### DYSON CUSTOMER CARE

##### THANK YOU FOR CHOOSING TO BUY A DYSON APPLIANCE.

After registering your 2 year guarantee, your Dyson appliance will be covered for parts and labour for 2 years from the date of purchase, subject to the terms of the guarantee. If you have any queries regarding your Dyson appliance, visit [www.dyson.co.uk/support](http://www.dyson.co.uk/support) or [www.dyson.ie/support](http://www.dyson.ie/support) for online help, general tips and useful information about Dyson.

Alternatively, you can call the Dyson Helpline with your serial number and details of where/when you bought the appliance.

Your serial number can be found on your rating plate which is on the base of the appliance.

If your Dyson appliance needs a service, call the Dyson Helpline so we can discuss the available options. If your Dyson appliance is under guarantee, and the repair is covered, it will be repaired at no cost.

#### PLEASE REGISTER AS A DYSON APPLIANCE OWNER

To help us ensure you receive prompt and efficient service, please register as a Dyson appliance owner. There are four ways to do this:

- Online at [www.dyson.co.uk/register](http://www.dyson.co.uk/register) or [www.dyson.ie/register](http://www.dyson.ie/register).

- Telephone the Dyson Helpline on 0800 298 0298 (UK) or 01 475 7109 (ROI).
- Complete the enclosed form and post it to us.
- Smartphone. Download the Dyson Link app and you will be taken through registration as part of the set up. This will confirm ownership of your Dyson appliance in the event of an insurance loss, and enable us to contact you if necessary.

#### LIMITED 2 YEAR GUARANTEE

##### TERMS AND CONDITIONS OF THE DYSON 2 YEAR LIMITED GUARANTEE

#### WHAT IS COVERED

- The repair or replacement of your Dyson appliance (at Dyson's discretion) if it is found to be defective due to faulty materials, workmanship or function within 2 years of purchase or delivery (if any part is no longer available or out of manufacture Dyson will replace it with a functional replacement part).
- Where this appliance is sold outside of the EU, this guarantee will only be valid if the appliance is used in the country in which it was sold.
- Where this appliance is sold within the EU, this guarantee will only be valid (i) if the appliance is used in the country in which it was sold or (ii) if the appliance is used in Austria, Belgium, France, Germany, Ireland, Italy, Netherlands, Spain or the United Kingdom and the same model as this appliance is sold at the same voltage rating in the relevant country.

#### WHAT IS NOT COVERED

- Replacement filter units. The appliance's filter units are not covered by the guarantee. Dyson does not guarantee the repair or replacement of a product where a defect is the result of:
- Damage caused by not carrying out the recommended appliance maintenance.
- Accidental damage, faults caused by negligent use or care, misuse, neglect, carelessness or operation or handling of the appliance which is not in accordance with the Dyson Operating Manual.
- Use of the appliance for anything other than normal domestic household purposes.
- Use of parts not assembled or installed in accordance with the instructions of Dyson.
- Use of parts and accessories which are not genuine Dyson components.
- Faulty installation (except where installed by Dyson).
- Repairs or alterations carried out by parties other than Dyson or its authorised agents.
- Blockages – Please refer to the 'Troubleshooting' section and illustrations in this Dyson Operating Manual for details of how to look for and clear blockages.
- Normal wear and tear (e.g. fuse etc.).
- Reduction in battery discharge time due to battery age or use (where applicable). If you are in any doubt as to what is covered by your guarantee, please contact the Dyson Helpline.

#### SUMMARY OF COVER

- The guarantee becomes effective at the date of purchase (or the date of delivery if this is later).
- You must provide proof of (both the original and any subsequent) delivery/purchase before any work can be carried out on your Dyson appliance. Without this proof, any work carried out will be chargeable. Keep your receipt or delivery note.
- All work will be carried out by Dyson or its authorised agents.
- Any parts which are replaced by Dyson will become the property of Dyson.
- The repair or replacement of your Dyson appliance under guarantee will not extend the period of guarantee.
- The guarantee provides benefits which are additional to and do not affect your statutory rights as a consumer.

#### PRIVACY AND PERSONAL DATA PROTECTION

You will need to provide us with basic contact information when you register your Dyson Product or the Dyson Link app;

When registering your Dyson product:

- You will need to provide us with basic contact information to register your product and enable us to support your guarantee.

#### WHEN REGISTERING VIA THE DYSON LINK APP

You will need to provide us with basic contact information to register the Dyson Link app; this enables us to securely link your product to your instance of the app.

- When you register, you will have the opportunity to choose whether you would like to receive communications from us. If you opt-in to communications from Dyson, we will send you details of special offers and news of our latest innovations. We never sell your information to third parties and only use information that you share with us as defined by our privacy policies which are available on our website: [privacy.dyson.com](http://privacy.dyson.com)

#### CONFORMITY INFORMATION

Hereby, Dyson declares that this environmental control radio equipment is in compliance with Directive 2014/53/EU.

The full text of the EU Declaration of Conformity is available at the following internet address:

[www.dyson.co.uk/inside-dyson/terms/compliance](http://www.dyson.co.uk/inside-dyson/terms/compliance) or  
[www.dyson.ie/inside-dyson/terms/compliance](http://www.dyson.ie/inside-dyson/terms/compliance).

#### Dyson Customer Care

If you have a question about your Dyson appliance, call the Dyson Helpline with your serial number and details of where and when you bought the appliance, or contact us via the Dyson website.

#### Dyson contact details

##### UK:

**Website:** [www.dyson.co.uk/support](http://www.dyson.co.uk/support)

**Dyson helpline:**  
0800 298 0298

##### Email:

[askdyson@dyson.co.uk](mailto:askdyson@dyson.co.uk)

##### Address:

Dyson Technology Limited, Tetbury Hill,  
Malmesbury, Wiltshire, SN16 0RP

##### ROI:

**Website:** [www.dyson.ie/support](http://www.dyson.ie/support)

**Dyson helpline:**  
01 475 7109

##### Email:

[askdyson@dyson.ie](mailto:askdyson@dyson.ie)

##### Address:

Dyson Ireland Limited, Office 2,  
Central Park, Leopardstown, Dublin 18,  
Ireland

## 4 easy ways to register your free 2 year guarantee



#### Register with your smartphone

Download the Dyson Link app and you will be taken through registration as part of the set up.



#### Register online

Visit our website to register your full parts and labour guarantee online.  
[www.dyson.co.uk/register](http://www.dyson.co.uk/register)  
[www.dyson.ie/register](http://www.dyson.ie/register)



#### Register by phone

Call our dedicated helpline.  
Open Monday to Friday 8am-8pm  
& Saturday and Sunday 8am-6pm.  
**UK:** 0800 298 0298  
**ROI:** 01 475 7109



#### Register by mail

Complete and return the form to Dyson in the envelope supplied.





